

PORTES EXTERIEURES

NOUVELLE
COLLECTION

ARTISAL



ISO 2000
FERMETURES

FABRICANT



Classico Aluminium | Prezo Aluminium | Ela Aluminium | Arti Verre

LES TEINTES RAL

 BLANC PUR RAL 9010	 BLANC SIGNALISATION RAL 9016	 GRIS CLAIR RAL 7035
 GRIS ANTHRACITE RAL 7016	 BRUN GRIS RAL 8019	 VERT MOUSSE RAL 6005

AUTRES TEINTES STANDARDS :
Différents coloris et/ou aspect bois,
possibles pour tous les modèles.



LES TEINTES RENOLIT

 CHÊNE DORÉ 2178/001-167	 WINCHESTER COVA 49240	 CHATAIGNER	 SAPELE 2065/021-167	 BISTRE BRUN NOIR	 SIENA ROSSO 49 233	 DOUGLAS STRIÉ
 BEIGE CRÈME	 BLANC 9016	 GRIS CLAIR	 GRIS ANTHRACITE 7016/05-167	 ANTHRACITE	 VERT FONCÉ 6125/05-167	 VERT MOUSSE
 CHÊNE CLAIR	 ROUGE VIN 300 505	 POURPRE ROUGE FONCÉ	 BLEU BRILLANT	 BLEU COBALT	 BLEU ACIER 5150/05-167	 GRIS BASALTE
 ARGENTÉ	 ARGENTÉ LISSE 7001	 GRIS CLAIR	 ALU BROSSÉ	 MARRON CHOCO 8875/05-167	 CHÊNE FONCÉ 2052/089-167	

LES POIGNÉES

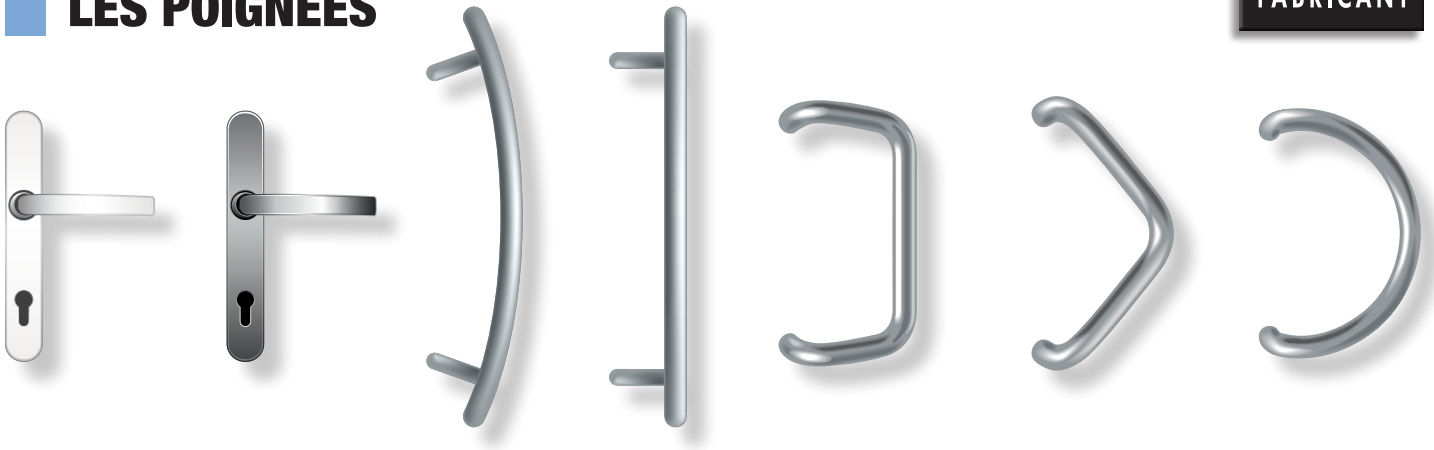

LES PAUMELLES

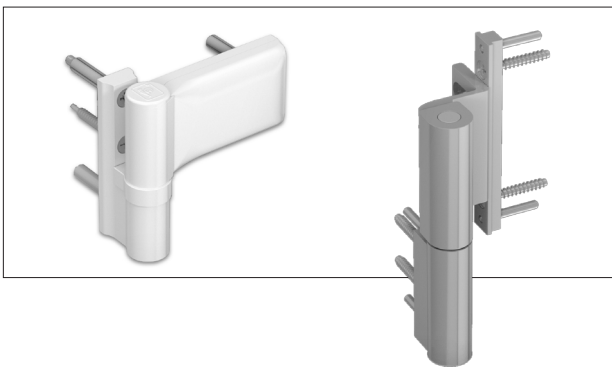

LES SERRURES



Serrure 3 points



Serrure 7 points

LES VITRAGES

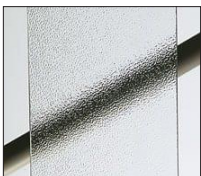

Imprimé
hors standard
Ornament 504



Imprimé
hors standard
Chinchilla blanc

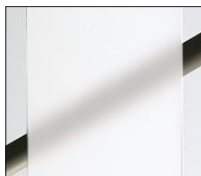

Imprimé
standard
Satinato blanc

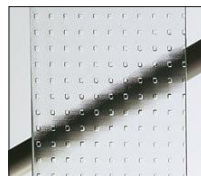

Imprimé
hors standard
Mastercarre

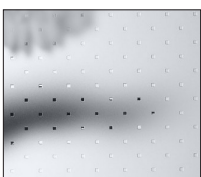

Imprimé
hors standard
Pave blanc



Imprimé
hors standard
Uadi blanc

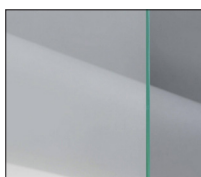

Imprimé
hors standard
Vitrage clair

LES BARILLETS



ARTISAL

LA MENUISERIE PVC ET ALUMINIUM DU PARTICULIER

📍 8 Rue de l'Oberlach
68520 BURNHAUPT-LE-BAS
☎ 03 89 62 72 72

📍 Zone Artisanale des Terrasses
28130 PIERRES
☎ 02 37 32 50 67

✉ contact@iso2000-fermetures.com
🌐 www.iso2000-fermetures.com

ACCUEIL

Tél. : 03 89 62 72 72
Fax. : 03 89 62 72 73

Site : www.iso2000fermetures.com

SECRÉTARIAT

Tél. : 03 89 62 72 72
Fax. : 03 89 62 72 73

E-mail : contact@iso-2000-fermetures.com

COMPTABILITÉ

Tél. : 03 89 62 72 71
Fax. : 03 89 62 72 88

E-mail : compta@3br.fr

DIRECTION

Tél. : 03 89 62 72 70
Fax. : 03 89 62 72 88

E-mail : rbattmann@3br.fr

SERVICE TECHNIQUE

Tél. : 03 89 62 72 72
Fax. : 03 89 62 72 87

E-mail : technique@artisal-menuiserie.com

SERVICE COMMERCIAL

Tél. : 03 89 62 72 72
Fax. : 03 89 62 72 73

E-mail : contact@iso-2000-fermetures.com

PANNEAUX VERRE ARTI

ARTISAL

ISO2000
FERMETURES

FABRICANT



Arti 1D



Arti 1G



Arti 2C



Arti 2D



Arti 2G



Arti 3D



Arti 3G



Arti 4D



Arti 4G



Arti 5D



Arti 5G



Arti 6D



Arti 7D



Arti 7G



Arti 8D



Arti 8G



Arti 9D



Arti 9G



Arti 10D



Arti 10G



Arti 11D



Arti 11G



Arti 12D



Arti 12G



Arti 13D



Arti 13G



Arti 14D



Arti 14G



Arti 15C



Arti 15D



Arti 15G

PANNEAUX ELA ALUMINIUM

ARTISAL

ISO2000
FERMETURES

FABRICANT



Ela 01*
Imprimé standard
Insert inox



Ela 02*
Imprimé standard
Insert inox



Ela 03
Imprimé standard
Insert inox



Ela 04*
Imprimé standard
Insert inox



Ela 05
Imprimé standard



Ela 06*
Imprimé standard



Ela 07*
Imprimé standard
Insert Inox



Ela 08
Imprimé standard
Insert inox



Ela 09
Imprimé standard
Insert inox



Ela 10
Imprimé standard
Insert inox



Ela 11*
Imprimé standard
Insert inox



Ela 12
Imprimé standard



Ela 13
Imprimé standard



Ela 14
Imprimé standard



Ela 30
Imprimé standard
Insert inox



Ela 31
Imprimé standard
Insert inox



Ela 32
Imprimé standard
Insert inox



Ela 33
Imprimé standard
Insert inox



Ela 34
Imprimé standard
Insert inox



Ela 35
Imprimé standard
Insert inox



Ela 36
Imprimé standard



Ela 37
Insert inox



Ela 38



Ela 39
Imprimé standard
Insert inox



Ela 40
Imprimé standard



Ela 41
Imprimé standard
Insert inox



Ela 42
Imprimé standard



Ela 43
Imprimé standard
Insert inox



Ela 44
Imprimé standard



Ela 45
Imprimé standard
Insert inox

PANNEAUX PREZO ALUMINIUM

ARTISAL

ISO2000
FERMETURES

FABRICANT



Prezo 01
Imprimé standard
Insert Inox



Prezo 02*
Imprimé standard



Prezo 03*
Imprimé standard
Insert Inox



Prezo 04*
Imprimé standard
Insert Inox



Prezo 06
Imprimé standard
Insert inox



Prezo 07*
Imprimé standard



Prezo 08
Imprimé standard



Prezo 12*
Imprimé standard
Insert inox



Prezo 20
Imprimé standard



Prezo 21*
Imprimé standard
Insert inox



Prezo 22
Imprimé standard
Insert inox



Prezo 23
Imprimé standard
Insert Inox



Prezo 24
Imprimé standard



Prezo 25
Imprimé standard
Insert inox



Prezo 26
Imprimé standard
Insert inox



Prezo 27
Imprimé standard
Insert inox



Prezo 28
Imprimé standard



Prezo 29
Imprimé standard
Insert inox



Prezo 30
Imprimé standard
Insert inox



Prezo 31
Imprimé standard
Insert inox



Prezo 32
Imprimé standard
Insert inox



Prezo 33
Imprimé standard
Insert inox



Prezo 34
Imprimé standard
Insert inox



Prezo 35
Vitrage double
Satinato au centre



Prezo 36
Vitrage double
Satinato à droite



Prezo 37
Ornement aspect inox
Vitrage double
Satinato 1 face feuilletée 33/2

*Possibilité bicolore
7016/9016

PANNEAUX CLASSICO ALUMINIUM

ARTISAL

ISO2000
FERMETURES

FABRICANT



Classico 02



Classico 02A



Classico 02D
Croisillons Laiton/blanc



Classico 03



Classico 03A



Classico 03D
Croisillons Laiton/blanc



Classico 04



Classico 04A



Classico 04D
Croisillons Laiton/blanc



Classico 05



Classico 05A



Classico 05D
Croisillons Laiton/blanc



Classico 06



Classico 06A



Classico 06B



Classico 06C



Classico 06D
Croisillons Laiton/blanc

**COMPOSITION
des panneaux en aluminium**

- Face aluminium 1,3 mm
- Ame isolante mousse PUW sans CFC
- Masse volumique 120 kg/m3



Classico 08



Classico 08A



Classico 08D
Croisillons Laiton/blanc



Classico 07



Classico 07A



Classico 07B



Classico 07C